

信興電工工程有限公司

SHUN HING ELECTRIC WORKS AND ENGINEERING CO., LTD.

辦公室：香港九龍尖沙咀東部麼地道67號半島中心9樓

電話：2861 2767

圖文傳真：2865 6706

網址：http://www.rasonic.com

電郵：shew@shunhinggroup.com

Office: 9/F, Peninsula Centre, 67 Mody Road, Tsimshatsui East, Kowloon, Hong Kong

Tel: 2861 2767

Fax: 2865 6706

Website: http://www.rasonic.com

E-mail: shew@shunhinggroup.com

保養及維修 Maintenance and Repair Service:

信興電器服務中心有限公司

SHUN HING ELECTRIC SERVICE CENTRE LTD.

香港新界葵涌勝耀街2號信興中心11樓

電話：2406 5666

圖文傳真：2408 0316

網址：http://www.shesc.com/zh

11/F, Shun Hing Centre, 2 Shing Yiu Street, Kwai Chung, N.T. HK

Tel: 2406 5666

Fax: 2408 0316

Website: http://www.shesc.com/zh

客戶服務中心：

香港新界葵涌勝耀街2號信興中心1樓

九龍尖沙咀東部麼地道67號半島中心8座9樓

香港天后琉璃街7號柏景中心22樓

澳門慕拉士大馬路193-199號南嶺工業大廈5樓1座

Customer Service Centre

1/F, Shun Hing Centre, 2 Shing Yiu Street, Kwai Chung, N.T.

9/F., Block B, Peninsula Centre, 67 Mody Road, Tsim Sha Tsui East, Kowloon

22/F, Parkview Centre, 7 Lau Li Street, Tin Hau, Hong Kong

Avenida de Venceslau de Morais, No. 193-199, 5 andar - I, Edf. Industrial Nam Leng, Macau

有關最新之香港及澳門客戶服務中心資料，請參閱信興服務中心網址：http://www.shesc.com/zh

For the latest information of Hong Kong and Macau service center, please visit http://www.shesc.com/en

Rasonic  
樂信牌

## RRC-JC10

微電腦電飯煲

Microcomputer Rice Cooker



僅供家庭使用  
For household use only

## 使用說明書 OPERATION MANUAL

- 在使用本產品前，請仔細閱讀本說明書，閱讀後小心收藏，以備日後查閱。  
Please read the operation manual carefully before using. Keep it in a safe place for future reference.
- 本說明書中的圖示可能與實物有不同的地方，僅供參考。  
The images in the operation manual may not match with the real object and are for reference only.



## 9. Special Avowal

1. The content in the operation manual has been checked. Our company reserves the hermeneutic power to any printing errors or misunderstanding on the content.
2. If there are technical improvements on the appliance, the operation manual will be updated in new version without prior notice. The product appearance and specification are subject to the manufacturer information.
3. In case there is any inconsistency or conflict between the English versions and Chinese versions of the terms, the Chinese versions shall prevail.
4. E-copy of user manual can be sent by e-mail on request, please call Shun Hing Electric Works & Engineering Co., Ltd. at 2861 2767.

## 10. After Sales Service

1. For any defect, in the judgement of technician from Shun Hing Electric Service Center Limited, caused under normal use, our company is responsible for repairing or replacing parts of the said electrical appliance free of charge within one year guarantee period commencing from the date of purchase. Any defect part which has been replaced shall become our property. Guarantee service does not cover the repair or replacement of consumable parts (e.g. inner pot) etc.
2. User must present the official invoice/redemption voucher and the product warranty card with the chop from sales point/redemption center for maintenance. For enquiries, please call Shun Hing Electric Service Center Limited hotline at 2406 5666.

非常感謝您選購樂信牌微電腦電飯煲，使用前請先詳細閱讀本說明書，並保存以備日後參考。



## 目錄

1. 安全注意事項
2. 保養、清潔及儲存
3. 產品規格
4. 產品結構
5. 內蓋安裝方法
6. 使用方法
7. 其他功能
8. 故障排除
9. 特別聲明
10. 售後服務

## 1. 安全注意事項







使用本產品時，必須遵守下列安全措施：

下圖表示由於錯誤操作而引起不同程度的危險等級。

 <b>警告：</b> 此標誌表示可能造成傷亡。
 <b>注意：</b> 此標誌表示可能造成傷害或財物損失。

以下不同標誌區分各種必須遵守的指示。

 此標誌表示禁止。
 此標誌表示必須遵守。

 <b>警告</b>	
 切勿讓小孩單獨使用、清潔及維修保養電飯煲或讓小孩玩耍器具。請將電飯煲及其電線放於小孩不能觸及的地方。	 請單獨使用額定電流10安培或以上及帶接地線插座。
 切勿擅自改裝電飯煲或使用非生產商提供的零件進行修理，否則可造成危險及維修保養無效。	 手濕時切勿接觸、插入或拔除插頭，否則可構成觸電的危險。
 切勿讓電飯煲在無人看管下或沒有內鍋時運作。	 切勿使用有殘缺或鬆動的插座。使用前，確保機身插座及電源插頭已充分擦乾。

## 7.2 Preset function

1. Connect the power, press [功能] Function key to select the function.
2. Press [預約] Preset key to set the preset time. Each press of [預約] Preset key, the preset time will increase by 30 minutes respectively. Display screen will show the time left.
3. After setting, press [開始] Start key to start the preset function. The rice cooker will be in the stand-by status and start cooking until it counts down to the function default cooking time.
  - ※ Do not preset the time over 12 hours to avoid food deterioration and bad smell.

## 8. Troubleshooting

Problem	Cause	Solution
1. Indication light does not work.	The power source is not connected properly.	Check whether the plug, socket and the power cord is in good condition and make sure the plug is firmly inserted into the socket.
	The plug or the internal parts are damaged.	Please send to Shun Hing Electric Service Centre Ltd. for checking and repairing.
2. Indication light is on but the heating plate is not heated.	The internal parts or the heating plate is damaged.	Please send to Shun Hing Electric Service Centre Ltd. for checking and repairing.
3. Rice is under-cooked or burnt.	The proportion of rice to water is incorrect.	Adjust the amount of water to rice with the correct proportion.
	Heating plate is deformed or the internal parts are damaged.	Please send to Shun Hing Electric Service Centre Ltd. for checking and repairing.
	The inner pot sits improperly on the heating plate.	Slightly turn the inner pot left and right until it fully contacts with the heating plate.
4. The porridge is overflowed.	Rice or water is too much.	Reduce proper amount of water and rice.
5. Display screen show E1、E2、E3 or E4.	The sensor is damaged.	Please send to Shun Hing Electric Service Centre Ltd. for checking or repairing.
6. The appliance fails to complete the cooking process according to the preset setting.	Forget to press [開始] Start key to confirm the preset setting.	Press [開始] Start key to confirm the preset setting.
7. Noise during cooking.	The noise produced is normal as the appliance auto-adjust the heating power.	The appliance is safe to use.
	There are foreign object obstructing the contact of the inner pot and the heating plate.	Remove the foreign object.

If the above solutions cannot fix the problem, please contact Shun Hing Electric Service Centre Ltd. to checking and repairing.









## 6.2 Rice / Porridge / Soup / Steam / Claypot Rice

1. Use the original measuring cup to measure rice, two full cups of rice are approximately for two to three persons.
2. Wash rice and add water.
  - (1) Put the rinsed rice in the inner pot. Do not wash rice directly inside the inner pot to avoid scratching the coating.
  - (2) Add suitable amount of water. To cook 2 cups of rice, add water to the inner pot until marking 2 on the "Cup" indication line. To cook porridge with 1/2 cup of rice, add water to the inner pot until marking 4.
    - ※ The water amount can be adjusted according to personal preference on the rice texture.
    - ※ Do not cook with hot water, it will affect the thermostat operation and the rice texture.
    - ※ Make sure the rice is evenly distributed in the inner pot.
3. Put the inner pot inside the rice cooker.
  - (1) Before putting in the inner pot, make sure the outer surface and bottom of the inner pot are wiped dry and clean. If foreign substance is attached on the heating plate, please remove it immediately. Otherwise, it will cause noise during cooking and possibly malfunction.
  - (2) Put the inner pot into the rice cooker and ensure it is directly in contact with the heating plate.
4. Close the lid until a "click" sound is heard.
5. Connect the power, a beep sound will be heard. It means it is in the stand-by status.
6. Press **[功能]** Function key to select the function until the white flash to the selected function. Press **[開始]** Start key to start cooking, the indication light will stay on.
7. After cook, 2 beep sounds will be heard. The indication light of selected function will be off, the display screen will show the "▣▣".
  - ※ It is recommended to keep the rice in keep-warm status for 10-15 minutes before served, the rice would become soft and taste better.
8. After use, press **[保溫 / 取消]** Keep Warm / Cancel key to return to stand-by status, then unplug the rice cooker from the power socket.

## 7 Other Functions

### 7.1 Keep warm function

1. When each cooking function is completed, the rice cooker will return to keep warm status.
2. In the stand-by status, press **[保溫 / 取消]** Keep Warm / Cancel key to activate the keep warm function, the display screen will show the "▣▣".
3. During keep warm, please stir the rice occasionally and close the lid. It is to avoid the rice becomes dry and clamp.
4. The maximum keep warm time is 24 hours, the rice cooker will then turn to stand-by status automatically.
5. Do not let the rice or food to keep warm for too long, otherwise it may have crust, bad smell and deterioration.
6. Press **[保溫 / 取消]** Keep Warm / Cancel key under keep-warm status to cancel the keep warm function.

 <b>警告</b>			
	為避免燙傷，使用時或剛使用後，切勿將臉或手靠近上蓋或蒸氣口；切勿觸摸剛使用後的發熱板及內鍋，因仍有餘熱。		此電飯煲只可作家庭或類似環境使用，如商店內部、辦事處和其他工作環境的員工廚房區域；旅館、汽車旅館和其他住宿類型的環境。
	使用後須進行清潔，切勿把機身、電源線或插頭浸入水中；或被水濺濕，並避免溢在連接器上，以免造成觸電及火災。		使用時，切勿用任何物件覆蓋電飯煲表面或遮擋蒸氣口，以免造成電飯煲故障、變形或變色。
	切勿使用變形的內鍋，以免因與發熱板接觸不良而引致故障。		使用前，確保電源線兩端的插頭已分別插穩在電飯煲及電源插座上。
	此電飯煲可供年齡在8歲或以上的兒童及體質、感覺或智力有障礙人士或缺乏經驗和相關知識的人士使用，但他們必須接受負責安全人士的監督或指導如何安全地使用電飯煲和理解所涉及的危險。		經常檢查電飯煲、內鍋、電源線及插頭，如有損壞，為避免危險，請立即停止使用，並聯絡信興電器服務中心有限公司安排檢查及維修。

⚠ 注意			
!	切勿使用其他器皿來取代原裝內鍋。	⊘	使用時，切勿打開上蓋、移動或搖晃電飯煲，以免造成危險。
!	使用前，確定內鍋外部及發熱板表面清潔乾爽，否則可能引致故障。	⊘	切勿使用內鍋直接淘米，以免損害內鍋表面的塗層，影響烹調效果。
⊘	切勿用火加熱內鍋，否則會損壞內鍋。	⊘	使用後要清潔，切勿用內鍋烹調酸性或鹼性的食物，以免損壞內鍋塗層。
!	煮食份量不可超過內鍋內最高水位線，否則可能有水從蒸氣口噴出。	⚡	在插入或拔除插頭時，應用手握穩插頭，不要抓住電源線。
⊘	切勿在電源線纏結的情況下使用或將電源線懸掛在桌子、櫥櫃的邊緣或讓它接觸灼熱的表面，否則會損壞電源線。	⊘	切勿在以下環境使用電飯煲： - 潮濕或近水的環境 - 靠近熱源如電焗爐、電磁爐及火源 - 不平穩的表面上 - 易燃物料或不耐熱物品附近(如枱布、窗簾及毛巾等)
!	使用後，請從電源插座拔出插頭及待電飯煲冷卻後才移動、清潔或檢查電飯煲。	⊘	不可在電源線上放重物、夾住、改裝、用力拉扯或扭曲電源線。

## 5. Inner Lid Assembly Description

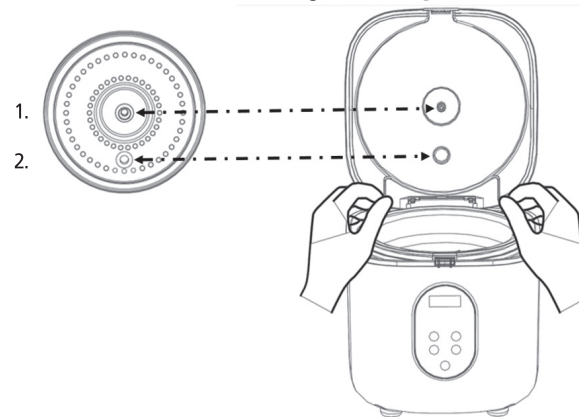

1. Probe seal
2. Vent hole seal

### CAUTION:

- When removing the inner lid, the probe sealing rubber ring may still be on the probe. Please install the probe sealing rubber ring on the probe hole of the inner cover. The installation direction of the probe sealing rubber ring is the same as that of the vent hole sealing rubber ring.

## 6. Operation Instructions

### 6.1 The cooking amount and time of different functions:

Function	Min. amount of cooking	Max. amount of cooking	Default cooking time	Keep warm	Preset
Rice (煮飯)	2 cups rice / 2-cup water level	6 cups rice / 6-cup water level	25 – 50 mins	✓	✓
Porridge (煮粥)	0.5 cup rice / 4-cup water level	1 cup rice / 6-cup water level	1 hr 30 mins	✓	✓
Claypotrice (煲仔飯)	2 cups rice / 2-cup water level	6 cups rice / 6-cup water level	30 mins	✓	✓
Soup (煲湯)	Do not add water above the maximum water level		2 hrs	✓	✓
Steam (蒸煮)	Do not add water below the minimum water level		15 mins	✓	✓

- ※ The cooking time for rice function is not adjustable.
- ※ When using the steam function, just fill in water in the inner pot, then place the food steam rack (not provided with appliance) to steam.
- ※ The actual rice cooking time is varied with different rice quantity, water amount, voltage, room temperature, water temperature and rice quality.
- ※ The rice texture is affected by different rice quality, water amount and rice quality which are even possible to form crust.

## 4. Product Descriptions

### Control Panel

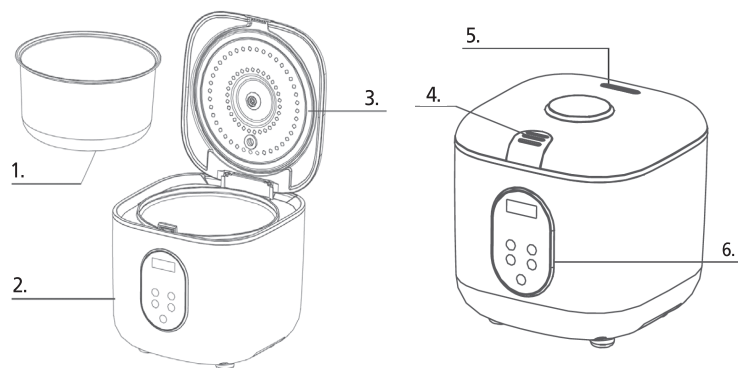

### Product Structures

1. Inner pot
2. Main body
3. Inner lid
4. Lid open button
5. Steam vent
6. Control panel
7. Measuring cup
8. Power cord
9. Rice scoop

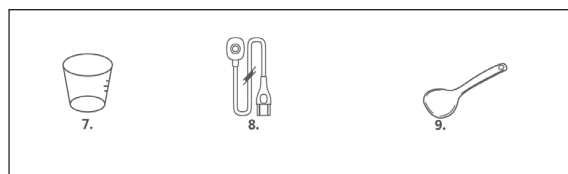

## 2. 保養、清潔及儲存

1. 清潔前，必須拔除電源插頭，並待電飯煲完全冷卻。
2. 清洗內鍋和內蓋時，請使用海綿等軟性物料及清潔劑，用水沖洗後再抹乾及裝回原位。
3. 如有食物黏在內鍋，清洗前可先用水浸泡一會。
4. 如發熱板、機身或上蓋有污穢，可用濕布抹淨後再抹乾。清潔時切勿將產品浸入水中。
5. 為免損壞內鍋塗層，盛飯時請使用原裝飯勺，切勿使用金屬餐具或在內鍋中切割食物。
6. 切勿使用有毒或含腐蝕性的清潔劑或粗硬的潔具(如鋼絲刷)進行清潔。
7. 長時間使用後，內鍋表面可能會變色，此乃正常現象並不會影響食物安全及內鍋的使用。
8. 儲存時，請將電飯煲放入紙箱並放置在乾爽的環境中。
9. 儲存時，切勿將電源線纏繞在電飯煲四周或壓住電源線，以免造成電源線損壞。

## 3. 產品規格

型號	RRC-JC10
額定電壓	220-240伏特~ 50-60赫茲
額定功率	500-600瓦
容量(約)最多6杯米)	1升(約)
淨重(約)	2.3公斤
產品尺寸(約)(闊 x 深 x 高)	245 x 255 x 240毫米

## 4. 產品結構

### 控制面板

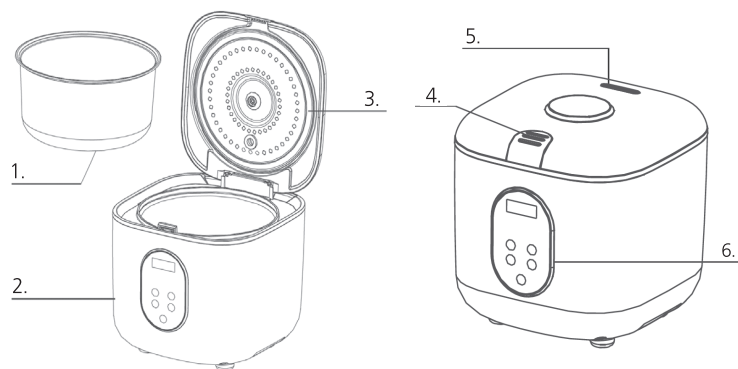

### 產品結構

1. 內鍋
2. 機身
3. 內蓋
4. 開蓋按鈕
5. 蒸氣出口
6. 控制面板
7. 量杯
8. 電源線
9. 飯勺

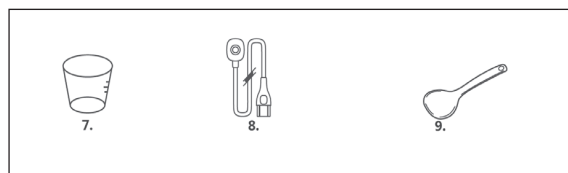

## 2. Maintenance, Cleaning and Storage

1. Before cleaning, the plug must be removed and let the rice cooker cool down completely.
2. When clean the inner pot and lid, please use soft materials such as sponge and detergent. Rinse with water and rub them dry. Put them in place after cleaned.
3. If food residual sticks on the inner pot, please soak the inner pot with water for a while before cleaning.
4. If dirt is attached on the heating plate, main body or lid, use a damp cloth to clean and wipe them dry. Do not immerse the appliance in water for cleaning.
5. To avoid damage on the inner pot coating, please use original rice scoop when serving rice, never use metal utensils or cut food in the inner pot.
6. Never use poisonous or corrosive detergent or harsh tools (e.g. metal-wired brush) for cleaning.
7. The color of inner pot may change after using a period of time, however it does not affect the food safety and function of the inner pot.
8. When store, put the appliance in a box and store in a dry place.
9. When store, never wrap the power cord around the appliance or clip the power cord to prevent power cord damage.

## 3. Product Specifications

Model	RRC-JC10
Rated Voltage	220-240V~ 50-60 Hz
Rated Power	500-600W
Capacity ((approx.) Max. 6 cup of rice)	1L (approx.)
Net Weight (approx.)	2.3 kg
Product Dimension (W x D x H) (approx.)	245 x 255 x 240 mm



! CAUTION			
!	The cooking amount cannot exceed the maximum water level of the inner pot to prevent water spilling from the steam vent.	! →	Grasp the plug itself when plug in or unplug the appliance, do not grasp the power cord.
/	Do not operate the appliance when the power cord is tangle or hang the power cord over the edge of table, counter-top or let it touch any hot surface, it may cause power cord damage.	/	Do not operate the appliance in the following places: <ul style="list-style-type: none"> <li>- Humid environment or near water</li> <li>- Near heat sources such as electric oven, induction cooker and fire</li> <li>- Unstable surface</li> <li>- Near inflammable or non-resistant to heat objects (e.g. table cloth, curtain and towel etc.)</li> </ul>
!	After use, please remove the plug and let the appliance cool down before moving, cleaning or checking.	/	Do not place heavy objects on the power cord. Never clip, modify, stretch or twist the power cord.

## 5. 內蓋安裝方法

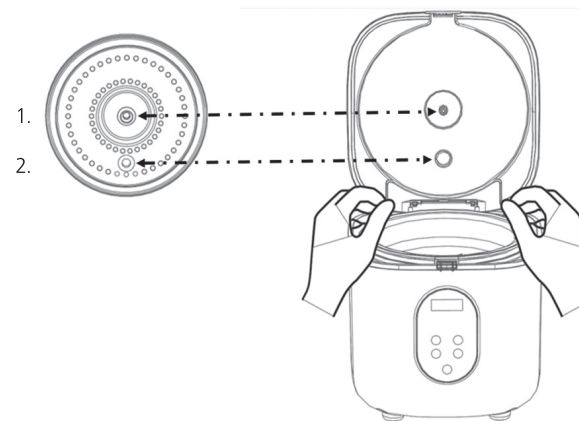

1. 探頭密封圈
2. 排氣孔密封圈

### 請注意：

- 拆卸內蓋時探頭密封膠圈有可能仍固定在探頭，請將探頭密封膠圈安裝於內蓋的探頭孔上。探頭密封膠圈的安裝方向與排氣孔密封膠圈一致。



## 6. 使用方法

### 6.1 各功能的烹調容量及時間

烹調功能	烹調最少分量	烹調最多分量	預設煮食時間	保溫	預約
煮飯	2 杯米 / 水位刻度 2 杯	6 杯米 / 水位刻度 6 杯	25 - 50分鐘	✓	✓
煮粥	0.5 杯米 / 水位刻度 4 杯	1 杯米 / 水位刻度 6 杯	1小時30分鐘	✓	✓
煲仔飯	2 杯米 / 水位刻度 2 杯	6 杯米 / 水位刻度 6 杯	30分鐘	✓	✓
煲湯	加水不可超過最高水位線		2小時	✓	✓
蒸煮	加水不可低於最低水位線		15分鐘	✓	✓



- ※ 煮飯功能的烹調時間不能調整。
- ※ 使用蒸煮功能時，只需在內膽注入適量的水，然後將盛好的食物放在蒸架上(本產品沒有配備蒸架)蒸煮。
- ※ 煮飯的實際時間會根據不同米量、水量、電壓、室溫、水溫及米質而變化。
- ※ 米飯的軟硬會因不同米量、水量及米質而影響，並有可能產生鍋巴。

## 6.2 煮飯 / 煮粥 / 煲湯 / 蒸煮 / 煲仔飯功能

1. 使用原裝量杯量米，2杯米平口盛滿，約二至三人食用量。
2. 洗米及加水
  - (1) 將清洗乾淨的米倒入內鍋。切勿在內鍋直接洗米，避免磨擦內鍋塗層。
  - (2) 加入適量的水。如煮2杯米的米飯份量，加水入內鍋至“Cup”水位線刻度2的位置。如煮1/2杯米的粥份量，加水入內鍋至水位線刻度4的位置。
    - ※ 用戶可按個人口感的喜好適量地調節水量。
    - ※ 切勿用熱水煮飯，否則會影響溫控器的運作及米飯的口感。
    - ※ 確保鍋內的米要均勻分佈。
3. 將內鍋放入電飯煲中。
  - (1) 放入內鍋前，請確保內鍋外側及底部已抹乾和清潔；如發熱板表面有異物，應立刻清除，否則煮食時會有雜聲及可能造成故障。
  - (2) 將內鍋平放於電飯煲內及確保內鍋與發熱板充分接觸。
4. 關上上蓋，直至聽到“咔嚓”一聲。
5. 連接電源，電飯煲會發出一聲響聲，顯示屏會顯示“- -”，表示處於待機狀態。
6. 按【功能】鍵選擇功能，直至所選功能燈閃亮。按【開始】鍵啟動功能，所選功能指示燈會轉為長亮。
7. 完成後，電飯煲會發出兩聲響聲。所選功能指示燈會熄滅，顯示窗會顯示“ ”。
  - ※ 建議讓米飯在電飯煲內保溫10-15分鐘才食用，米飯會更鬆軟可口。
8. 使用後，按【保溫 / 取消】鍵回到待機狀態，並拔除電源插頭。

## 7. 其他功能



### 7.1 保溫功能

1. 各功能完成後，電飯煲均會進入保溫狀態。
2. 在待機狀態下，按【保溫 / 取消】鍵可啟動保溫功能，顯示窗會顯示“ ”。
3. 保溫時，請將米飯翻鬆及關上上蓋，以免米飯變乾及結塊。
4. 保溫時間最長為24小時，之後電飯煲會自動轉為待機狀態。
5. 切勿將米飯或食物保溫過長時間，否則會產生鍋巴、異味及食物變質。
6. 在保溫狀態下，按【保溫 / 取消】鍵，可取消保溫功能。







### 7.2 預約功能









1. 接通電源，按【功能】鍵選擇功能。
2. 按【預約】鍵開始設定預約，若需調整預約時間，每按【預約】鍵一次，時間值會遞增30分鐘，顯示窗會顯示倒數時間。
3. 設定後，按【開始】鍵啟動預約功能。電飯煲會處於待機狀態直至需要烹調時才會啟動預設烹調功能。
  - ※ 建議預約時間不要超過12小時，以免食物變質及產生異味。

## ! WARNING

	<p>The appliance can be used by children aged from 8 years and above and persons with reduced physical, sensory or mental capabilities, or lack of experience and knowledge, if they have given supervision or instruction concerning use of the appliance in a safe way and understand the hazards involved.</p>		<p>Always check the condition of the appliance, inner pot, power cord and plug. If any of the parts is damaged, stop using the appliance immediately to avoid hazard and contact Shun Hing Electric Service Centre Limited for checking and repairing.</p>
---	---	---	--

## ! CAUTION

	<p>Do not use other container to substitute the original inner pot.</p>		<p>Do not open the lid, move or shake the appliance when in use, it can cause danger.</p>
	<p>Make sure the inner pot outer surface and heating plate are clean and dry before use, otherwise it may cause malfunction.</p>		<p>Do not wash rice directly inside the inner pot to avoid scratching the coating and affect the cooking performance.</p>
	<p>Do not heat the inner pot with fire, it will cause damage.</p>		<p>Clean after use. Do not cook acidic or alkaline food in the inner pot to avoid damage on the inner pot coating.</p>

 <b>WARNING</b>			
	Never leave the appliance unattended when in use or operate without inner pot.		Do not use deficient or loosen socket. Make sure the appliance inlet and plug are dry before use.
	To avoid burn, do not get your face or hands close to the lid or steam vent during use or right after use; never touch the heating plate and inner pot which are subject to residual heat right after use.		The appliance is intended to be used in household or similar applications such as staff kitchen in shops, offices and other working environments; by clients in hotels, motels and other residential type environments.
	Normally cleaned after use and not intended to be immersed in water for cleaning. Never immerse the main body, power cord or plug in water or let them wet and avoid spillage on the connector, it can cause electric shock and fire.		When in use, do not cover the appliance surface or steam vent with any objects to avoid appliance malfunction, deformation or discoloration.
	Do not use deformed inner pot to avoid malfunction due to poor contact with heating plate.		Before use, please make sure both ends of the power cord are plugged in tightly on the appliance and the power socket.

## 8. 故障排除

故障現象	原因	解決方法
1. 指示燈不亮。	電源尚未連接穩妥。	檢查插頭、插座及電源線是否完好，以及是否完全插入插座。
	電源插頭或內部零件損壞。	送回信興電器服務中心有限公司檢查及維修。
2. 指示燈亮起，發熱板不熱。	內部零件或發熱板零件損壞。	送回信興電器服務中心有限公司進行檢查及維修。
	3. 飯煮不熟或米飯煮焦。	米量及水量的比例不正確。
4. 煮粥時溢出。	發熱板變形或內部零件損壞。	送回信興電器服務中心有限公司進行檢查及維修。
	內鍋未有水平放置於發熱板上。	將內鍋輕輕轉動直至與發熱板充分接觸。
5. 顯示窗出現E1、E2、E3或E4。	米量或水量過多。	適量減少米或水。
6. 沒有在預約的時間完成煮飯功能。	傳感器出現故障。	送回信興電器服務中心有限公司檢查及維修。
7. 煮飯時，有奇怪的聲音。	沒有按【開始】鍵啟動設定。	按【開始】鍵啟動預約功能。
	輕微的“咔嚓”聲，是自動調整火力的聲音，屬正常現象。	電飯煲是安全的，可繼續使用。
	內鍋與發熱板之間有異物影響接觸。	清除異物。

如以上方法未能使電飯煲恢復正常操作，請聯絡信興電器服務中心有限公司進行檢查及維修。

## 9. 特別聲明

1. 本資料上所有內容經過核對，如有任何印刷及內容上的誤解，本公司將保留解釋權。
2. 本產品若有技術改進，會編進新版說明書中，恕不另行通知；產品外觀、顏色如有改動，則以製造商生產資料為準。
3. 如本資料之中英文版本有差異時，應以中文版為準。
4. 使用說明書的電子副本可以通過電子郵件發送致客戶，如有需要，可致電信興電工工程有限公司：2861 2767。

## 10. 售後服務

1. 由購買收據日期起之一年保修期內，經信興電器服務中心有限公司之服務人員證實產品故障屬於正常使用之情況下發生者，本公司將提供免費維修或更換零件服務。經更換之任何損壞零件，將歸屬本公司所有。保修範圍不包括修理或更換產品之損耗性零件(例如：內鍋)等。
2. 用戶必須於維修時出示購買收據／換購收據及蓋有銷售點／換購中心印章的產品保修記錄卡。如有任何疑問，請致電信興電器服務中心有限公司熱線：2406 5666查詢。



Thank you for choosing Rasonic microcomputer rice cooker. Please read the operation manual carefully before use and keep it for your future reference.

## Table of Contents



1. Important Safeguards
2. Maintenance, Cleaning and Storage
3. Product Specifications
4. Product Descriptions
5. Inner Lid Assembly Description
6. Operation Instructions
7. Other Functions
8. Troubleshooting
9. Special Avowal
10. After Sales Service





## 1. Important Safeguards

When using the appliance, please follow the below safety precautions: The following chart indicates the degree of damage caused by wrong operation.

	<b>WARNING:</b> Indicates that may cause death or serious injury.
	<b>CAUTION:</b> Indicates hazards that may cause human injuries or property damages.

The following symbols can distinguish the instruction types that need to be strictly followed.

	These symbols mean prohibition.
	These symbols mean requirement that must be followed.

 <b>WARNING</b>	
	Never allow children to operate, clean, perform maintenance on the appliance alone or play with the appliance. Please put the appliance and its power cord in a place not reachable by children.
	Please use an individual socket with rated current 10A plug or above and earth wire.
	Do not attempt to modify the appliance by yourself or repair with any unauthorized parts, otherwise it will cause hazards and warranty will become invalid.
	Do not touch, plug in or remove the plug with wet hands, it can cause electric shock.